



INSTALLATION INSTRUCTION

LED DESIGNER CEILING LIGHT

TECHNICAL DATA

MODEL	VT-7907
WATTS	37W
LUMENS	4000LM
BEAM ANGLE	360°
MATERIAL	Metal+Silicone+Acrylic
BASE SIZE	D200 x H35mm
DIMENSION	D495mm
INPUT POWER	AC: 180-240V, 50Hz



INTRODUCTION & WARRANTY

Thank you for selecting and buying V-TAC product. V-TAC will serve you the best. Please read these instructions carefully before starting the installation and keep this manual handy for future reference. If you have any another query, please contact our dealer or local vendor from whom you have purchased the product. They are trained and ready to serve you at the best. The warranty is valid for 3 years from the date of purchase. The warranty does not apply to damage caused by incorrect installation or abnormal wear and tear. The company gives no warranty against damage to any surface due to incorrect removal and installation of the product. The products are suitable for 10-12 Hours Daily operation. Usage of product for 24 Hours a day would void the warranty. This product is warranted for manufacturing defects only.

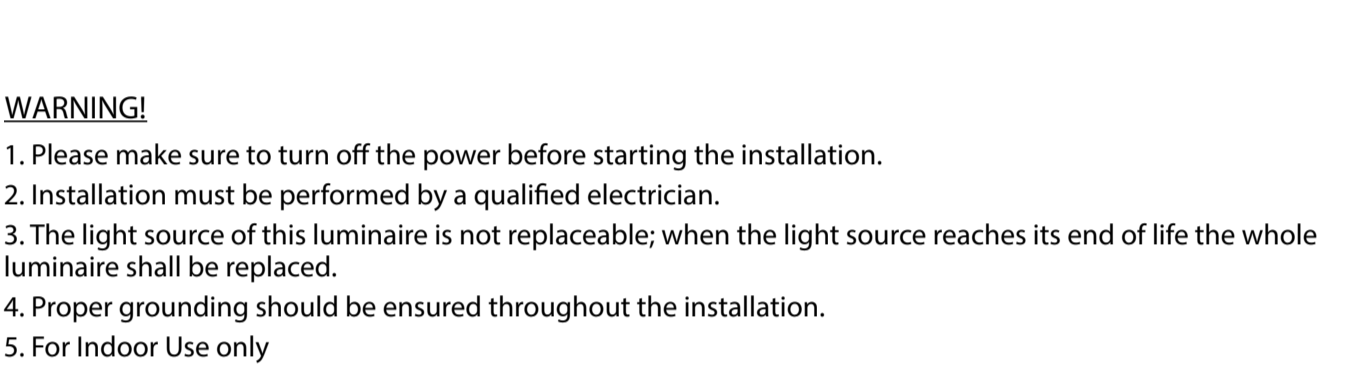

WARNING!

- Please make sure to turn off the power before starting the installation.
- Installation must be performed by a qualified electrician.
- The light source of this luminaire is not replaceable; when the light source reaches its end of life the whole luminaire shall be replaced.
- Proper grounding should be ensured throughout the installation.
- For Indoor Use only

 This marking indicates that this product should not be disposed of with other household wastes.

 Caution, risk of electric shock.



[FR] INTRODUCTION & GARANTIE

Merci d'avoir choisi et acheté un produit à V-TAC. V-TAC vous offrira le meilleur. Veuillez lire attentivement ces instructions avant de commencer l'installation et conservez ce manuel à portée de main pour référence ultérieure. Si vous avez d'autres questions, veuillez contacter notre distributeur ou le fournisseur local auprès duquel vous avez acheté le produit. Ils sont formés et prêts pour servir au mieux. La garantie est valable pour une période de 3 ans à compter de la date d'achat. La garantie ne s'applique pas à des dommages causés par une installation incorrecte ou une usure anormale. La société ne donne aucune garantie pour des dommages causés à une surface en raison d'un enlèvement et d'une installation incorrects du produit. Les produits sont convensables pour une exploitation quotidienne de 10-12 heures. Utilisation du produit pendant 24 heures par jour annule la garantie. Ce produit est couvert par une garantie pour des défauts de fabrication seulement.

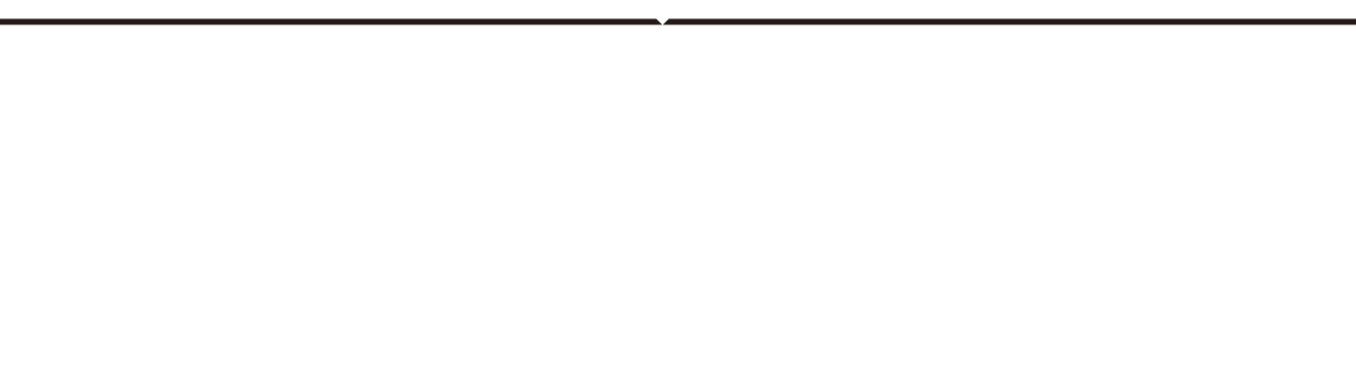
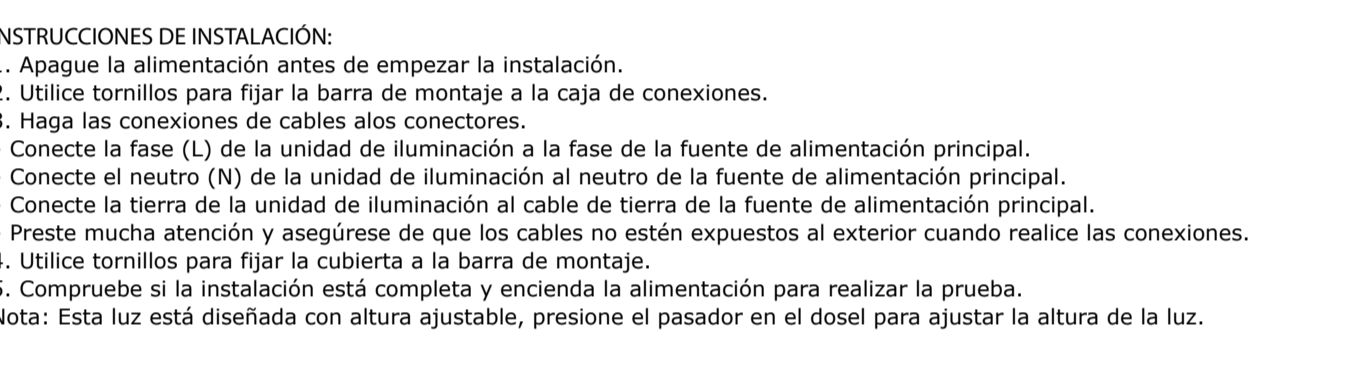
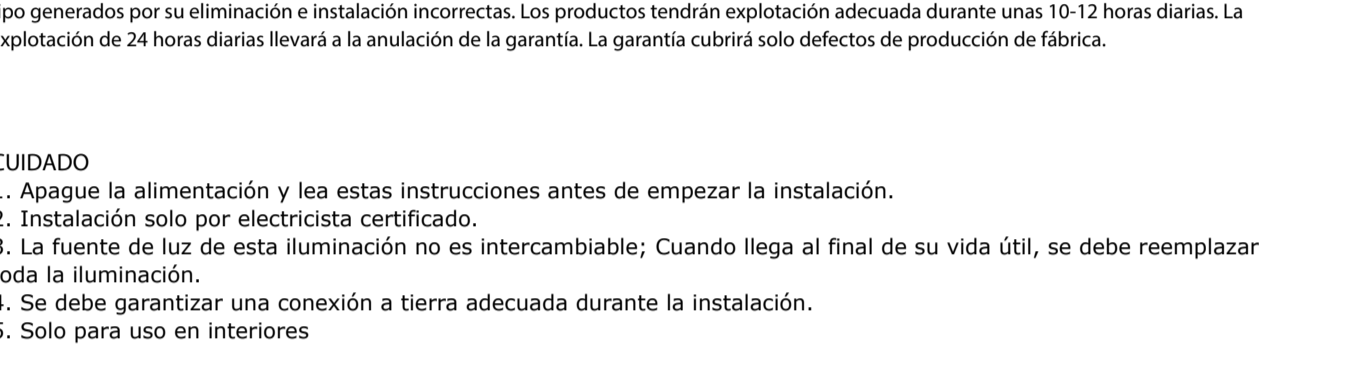
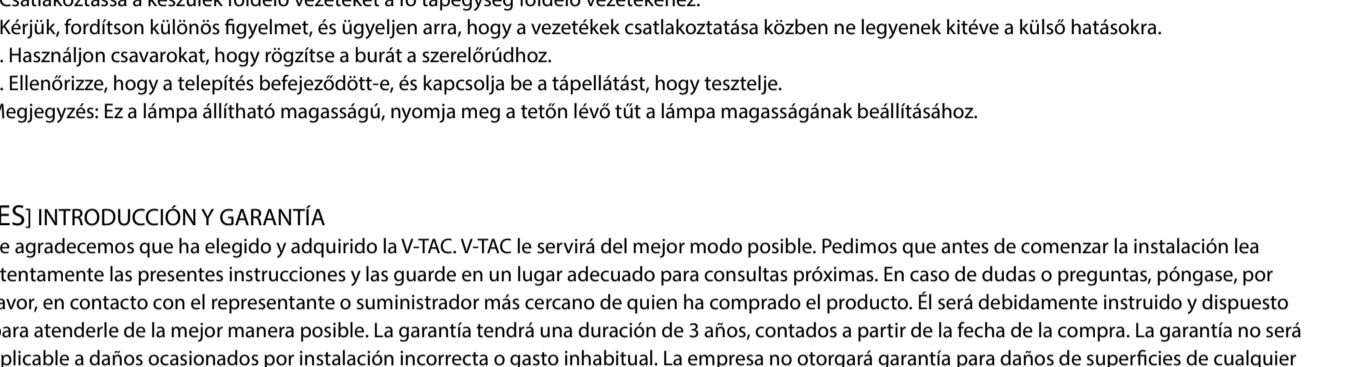
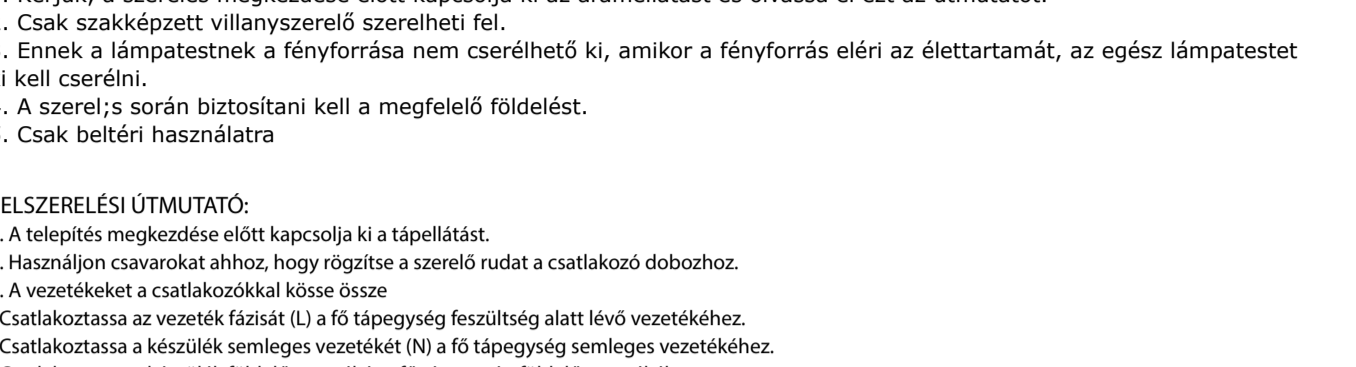
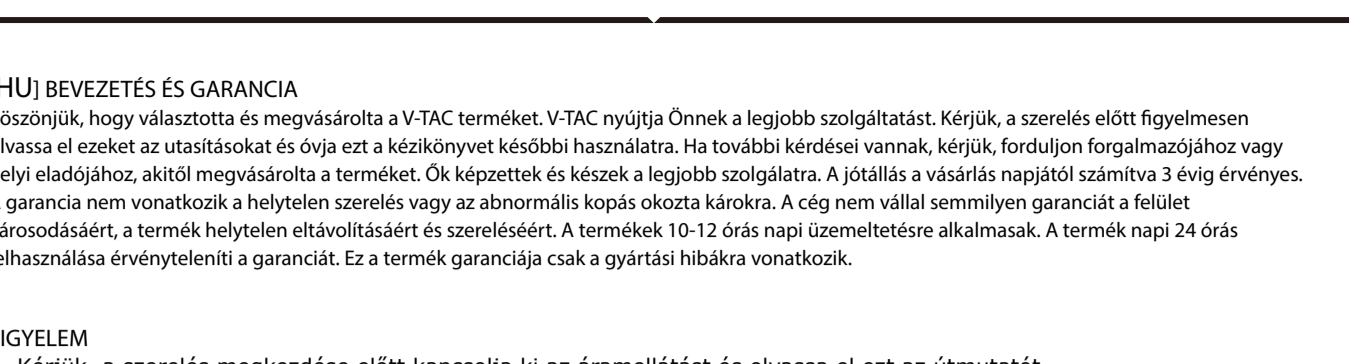
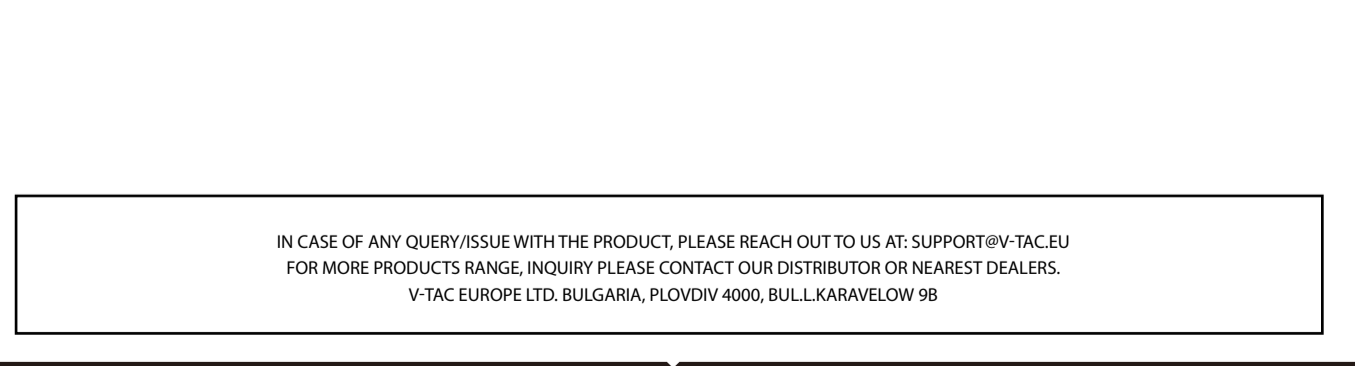
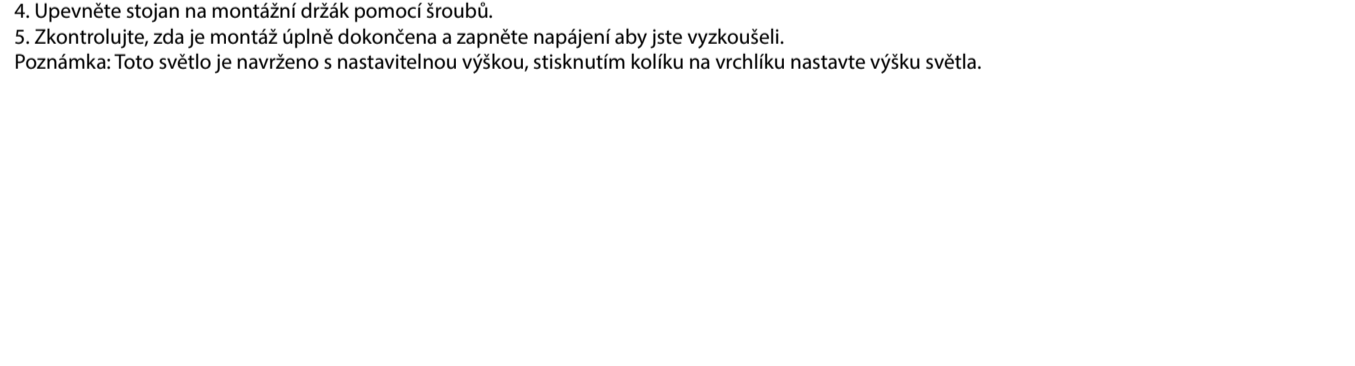
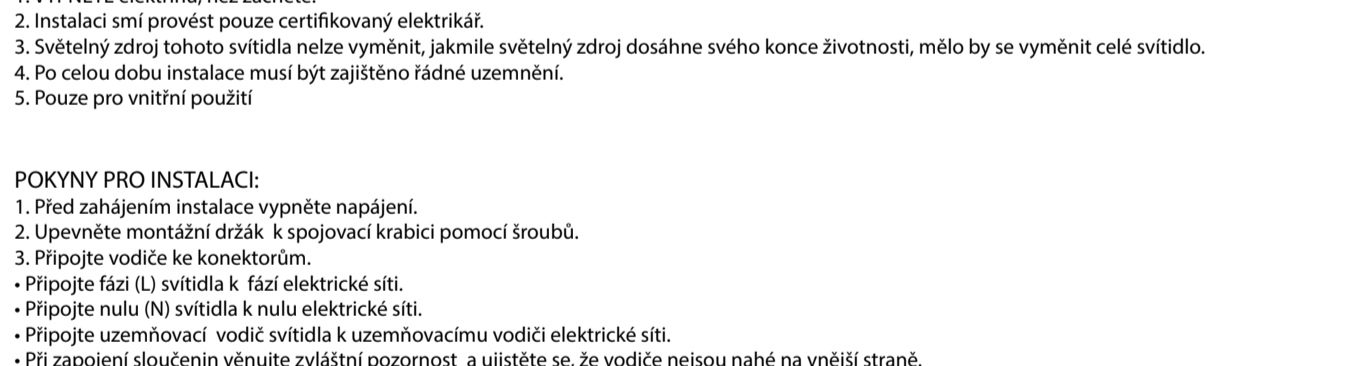
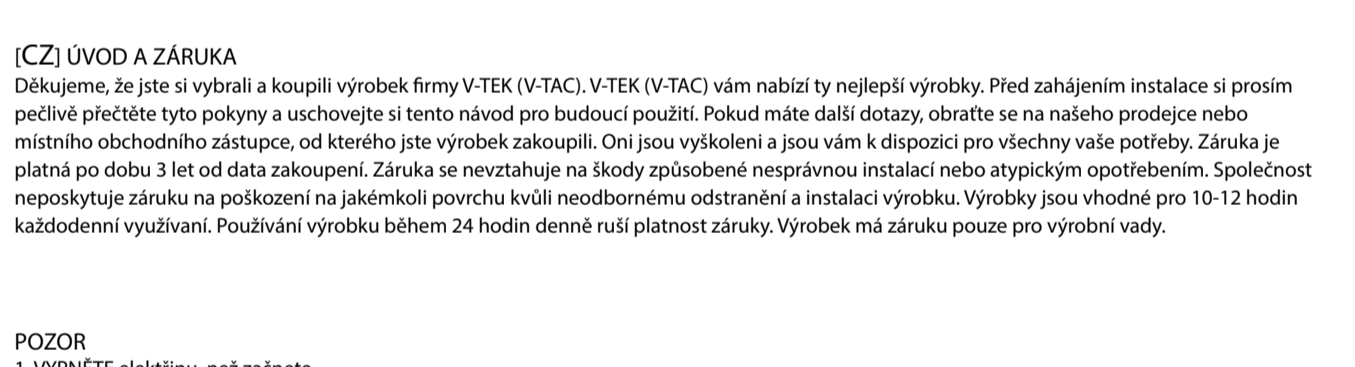
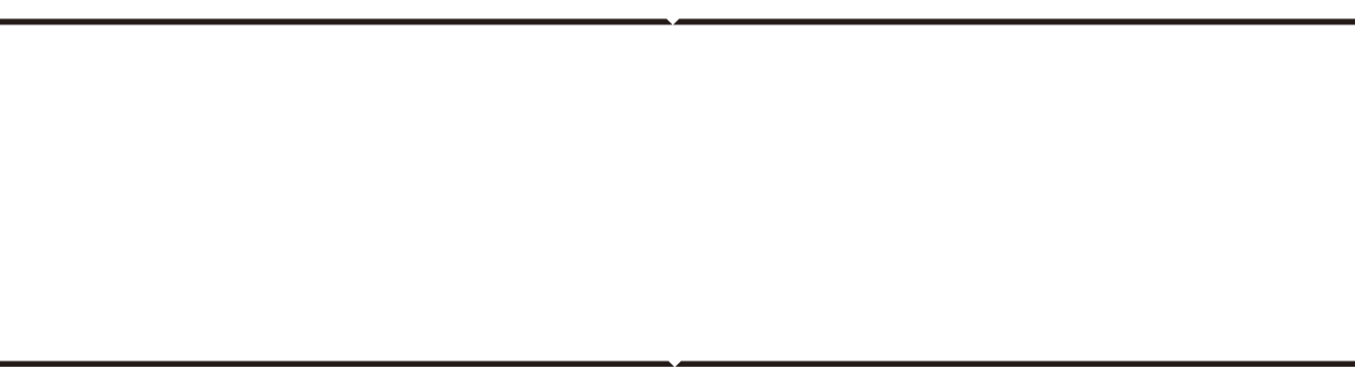
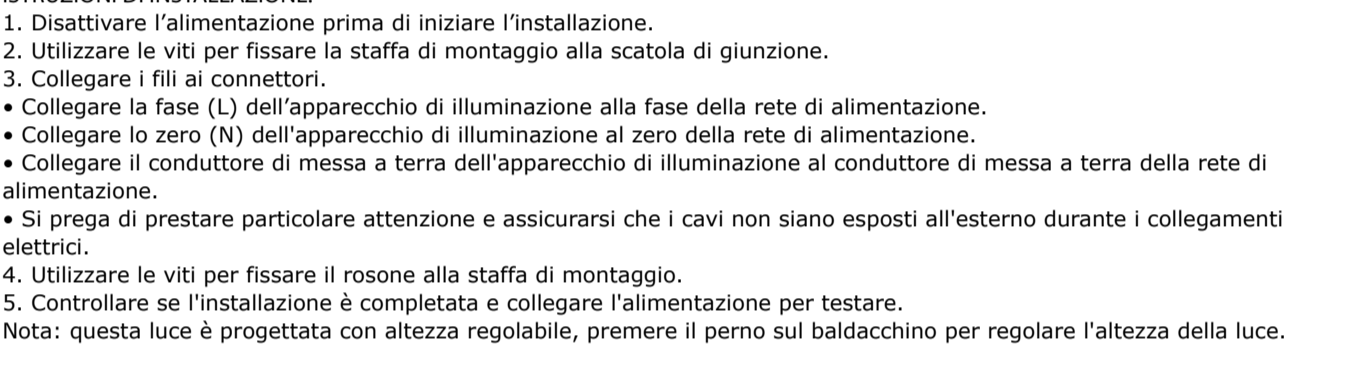
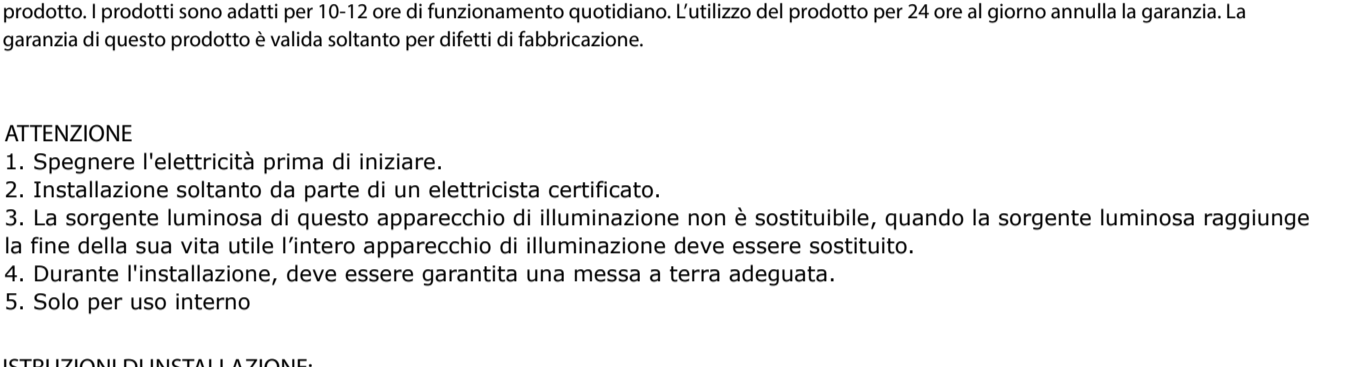
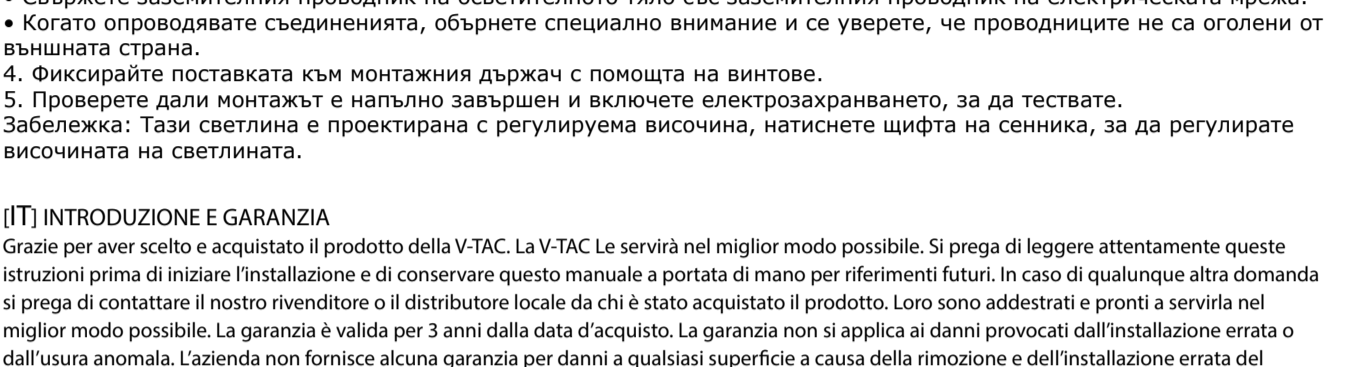
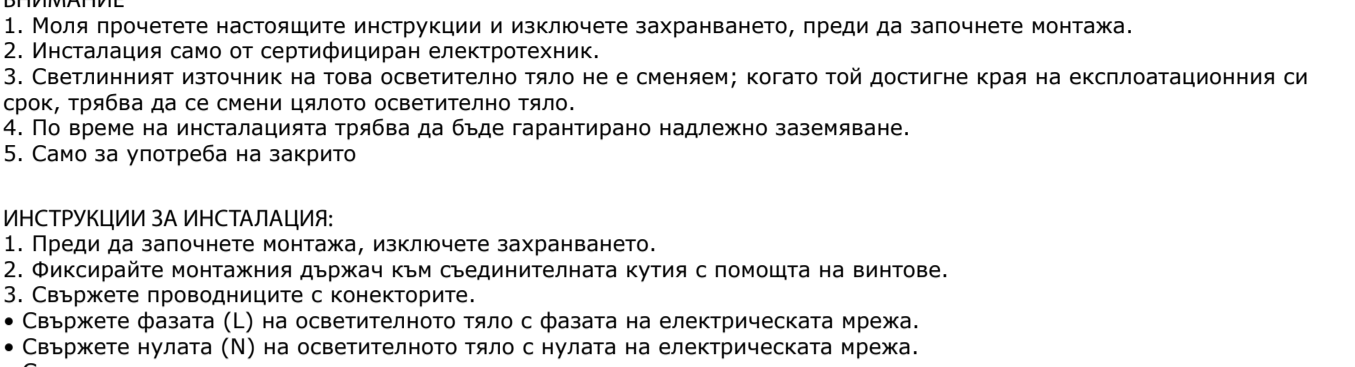
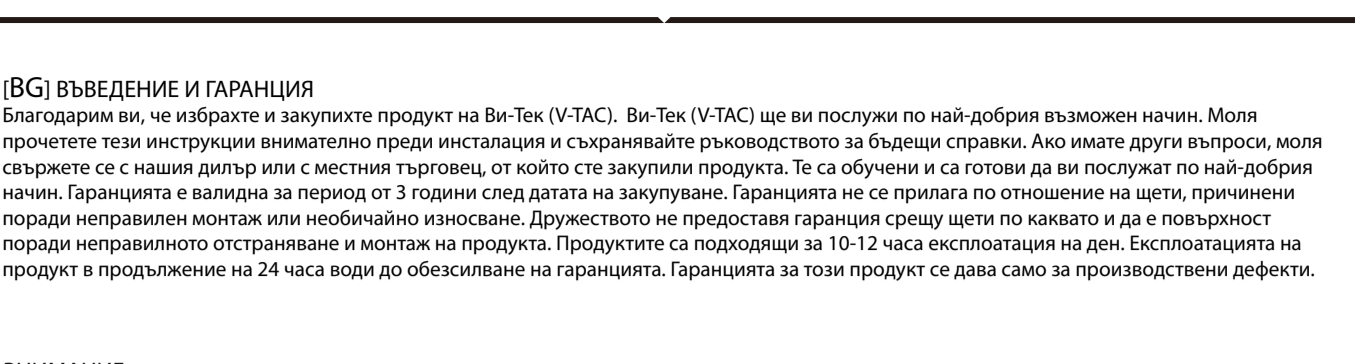
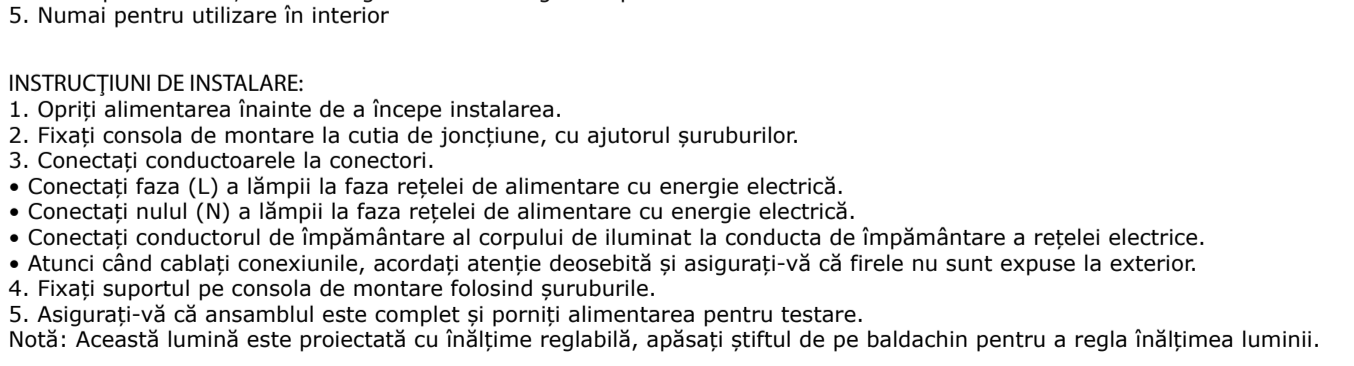
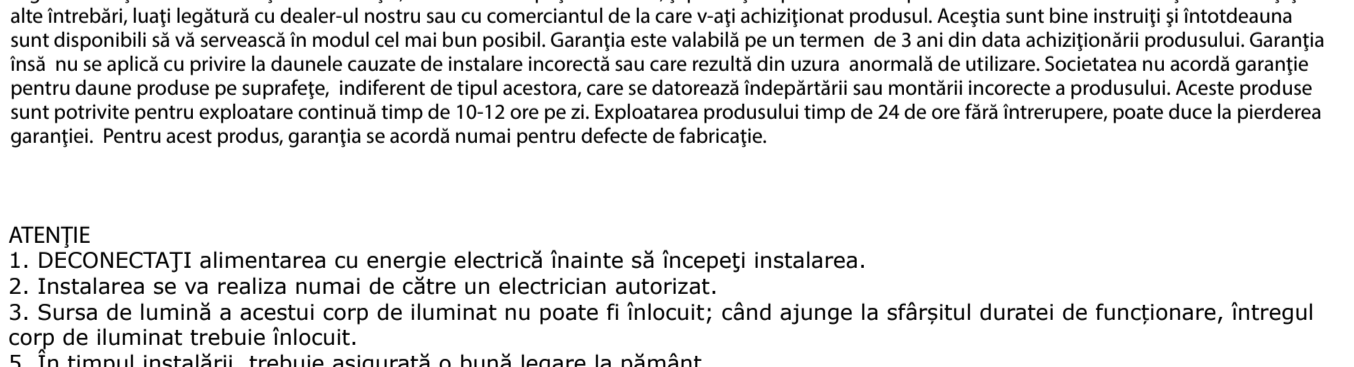
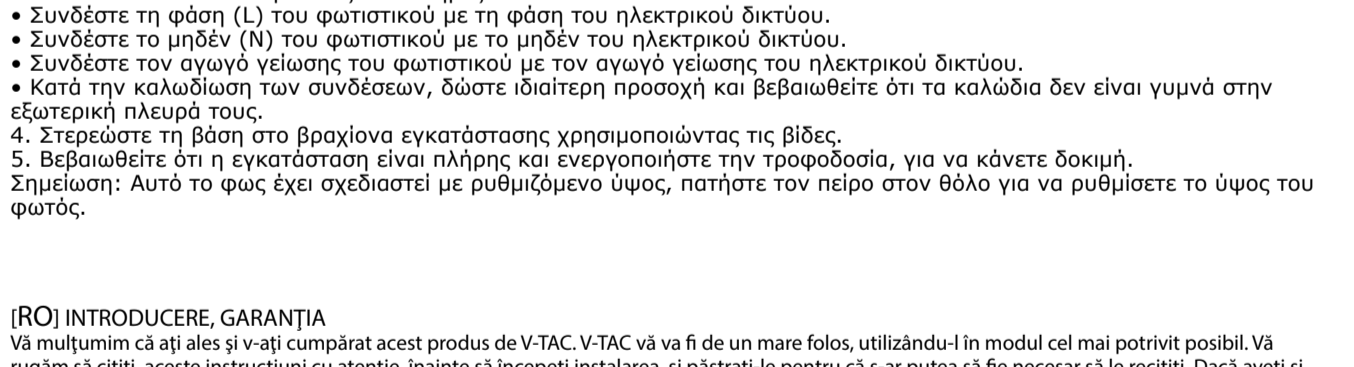
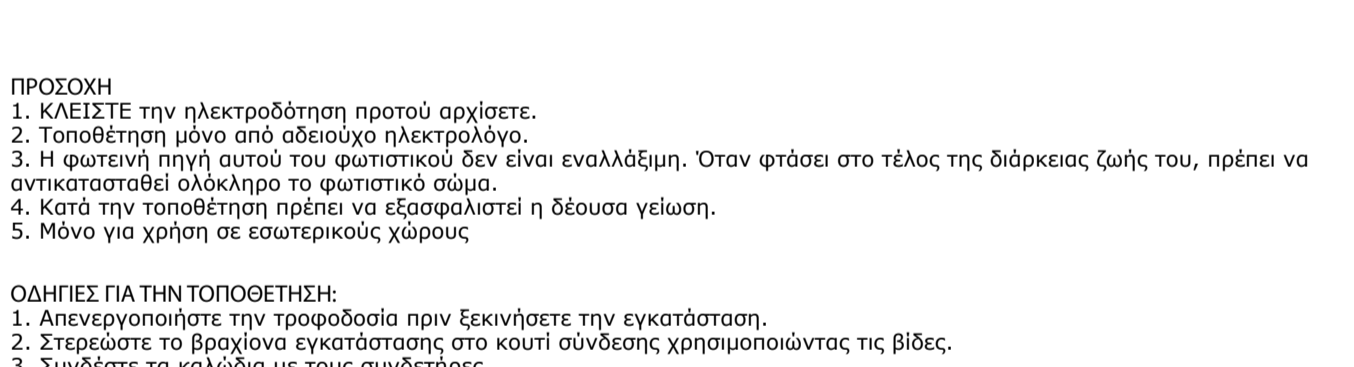
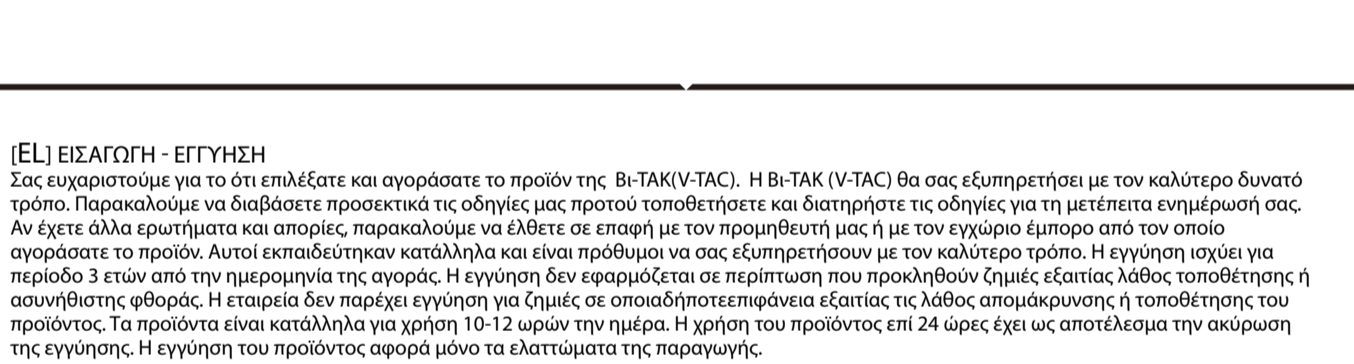
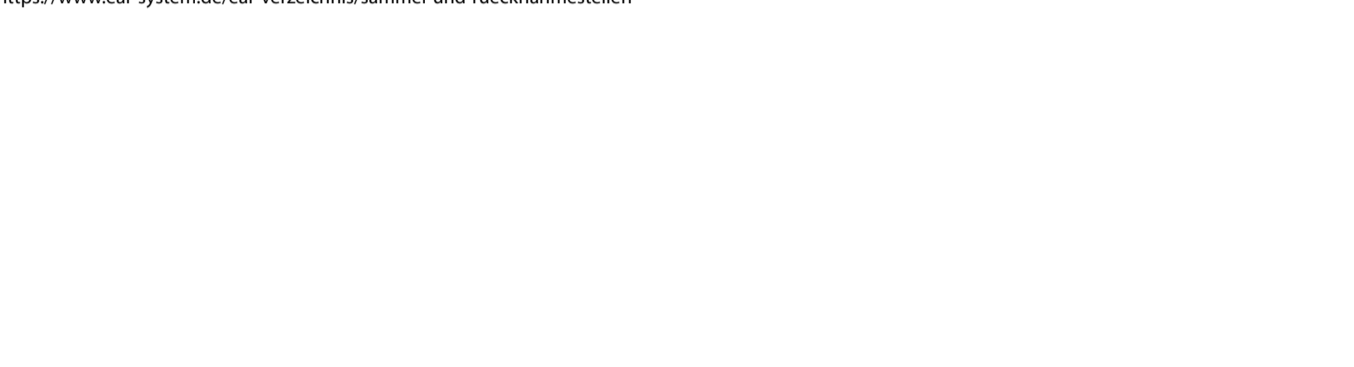
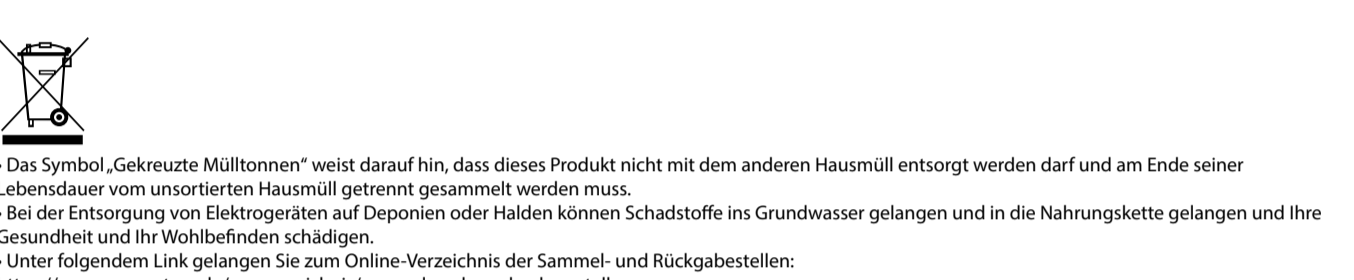
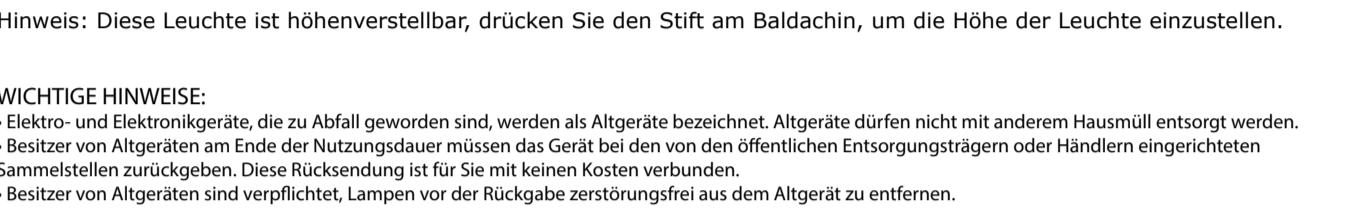
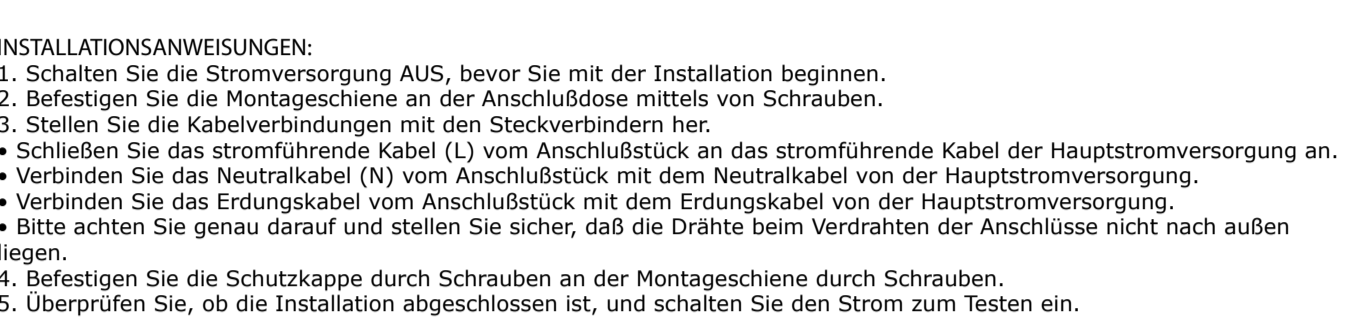
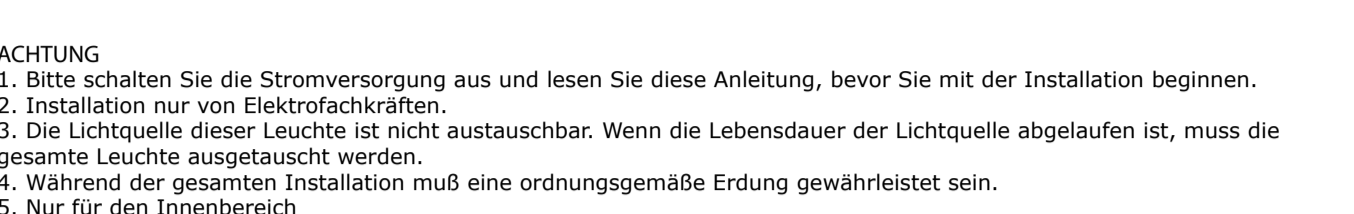
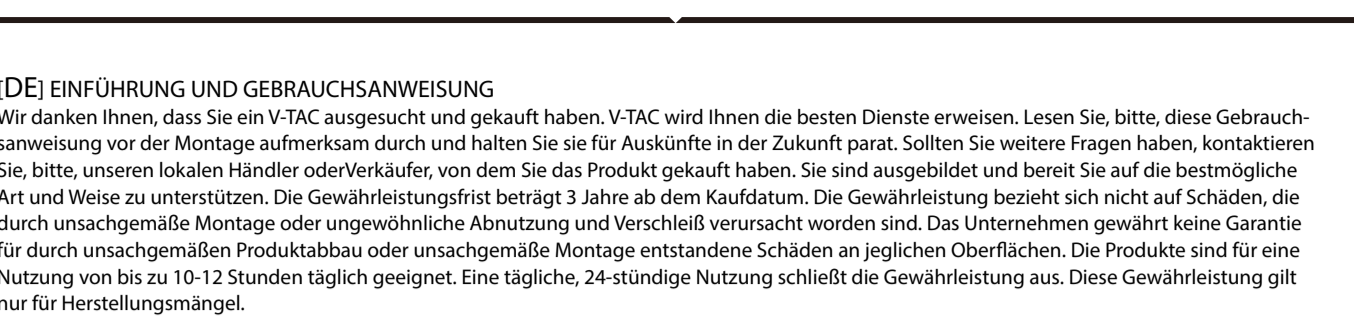
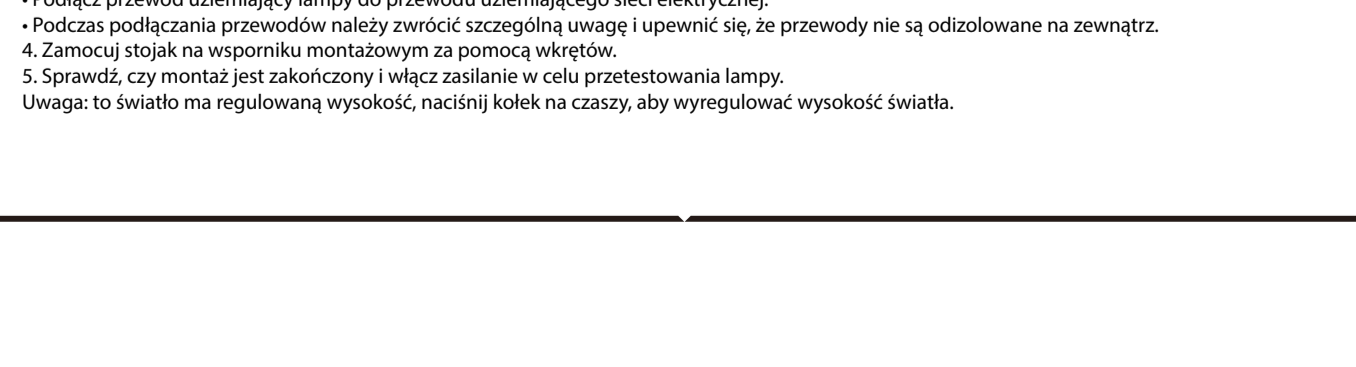
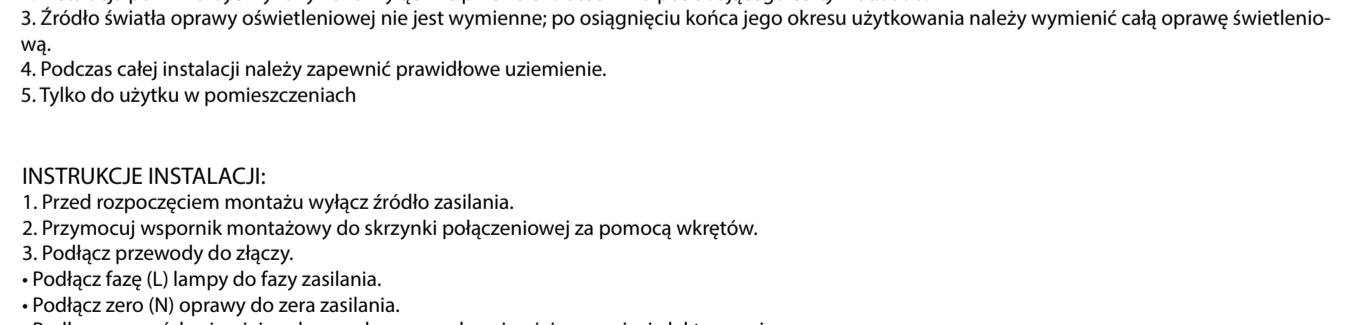
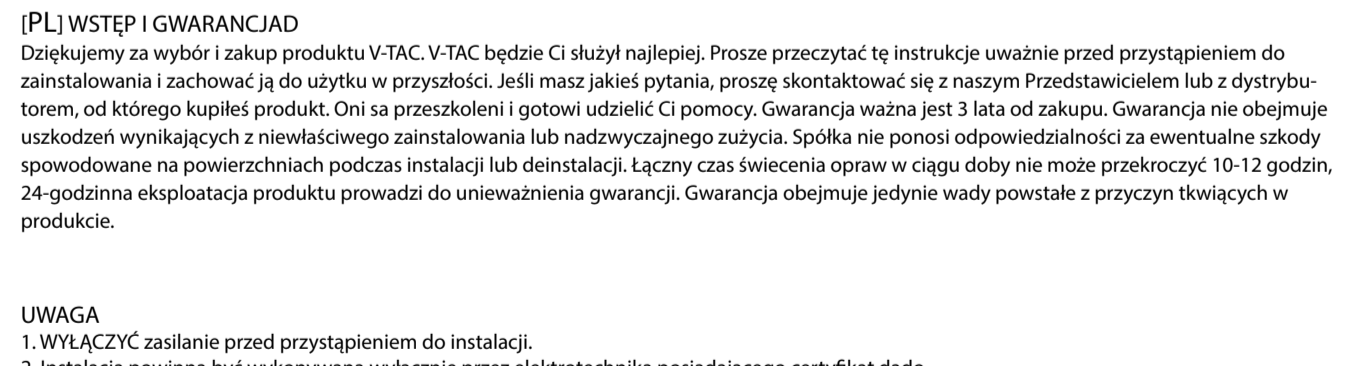
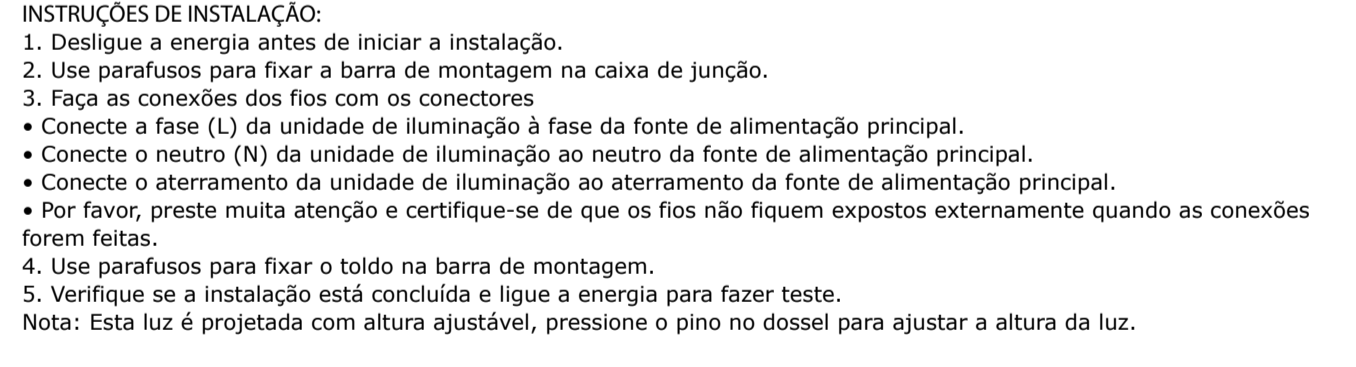
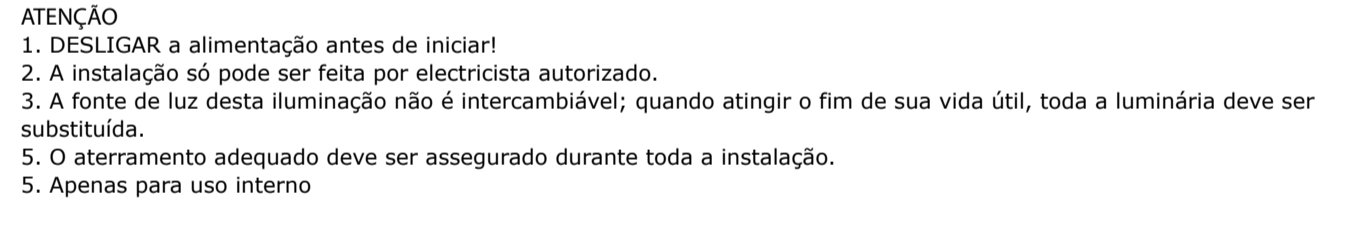
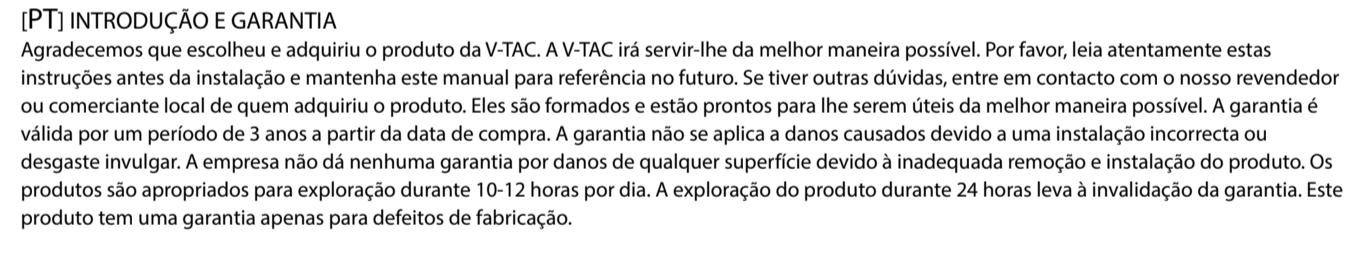
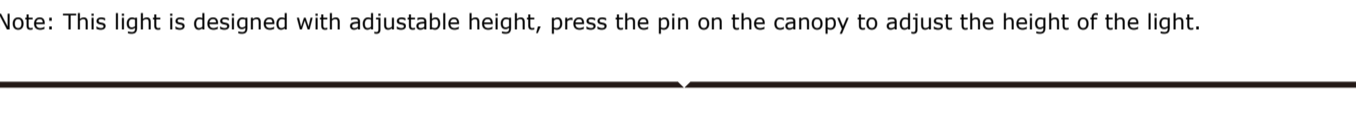
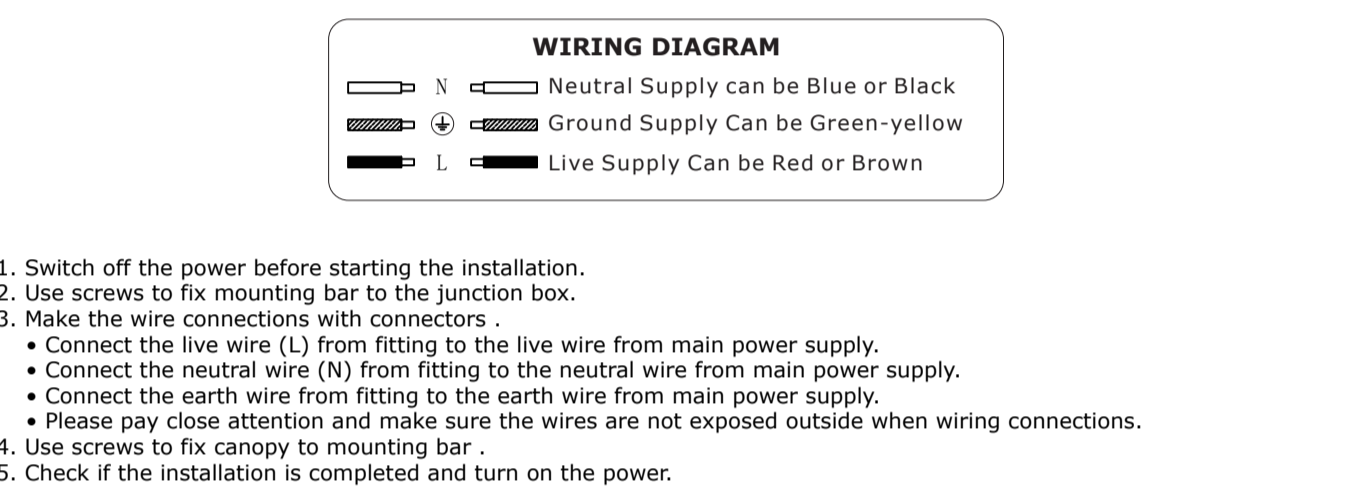
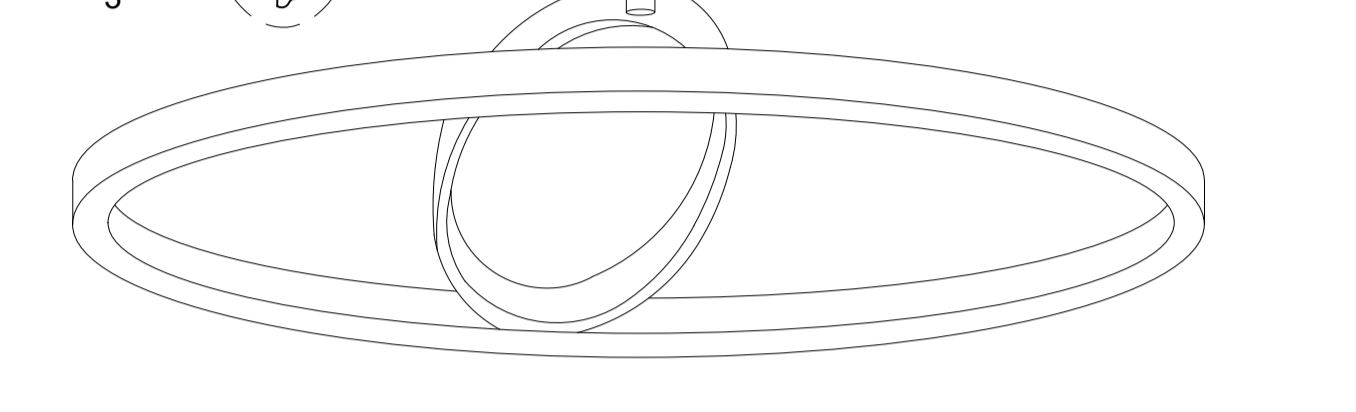
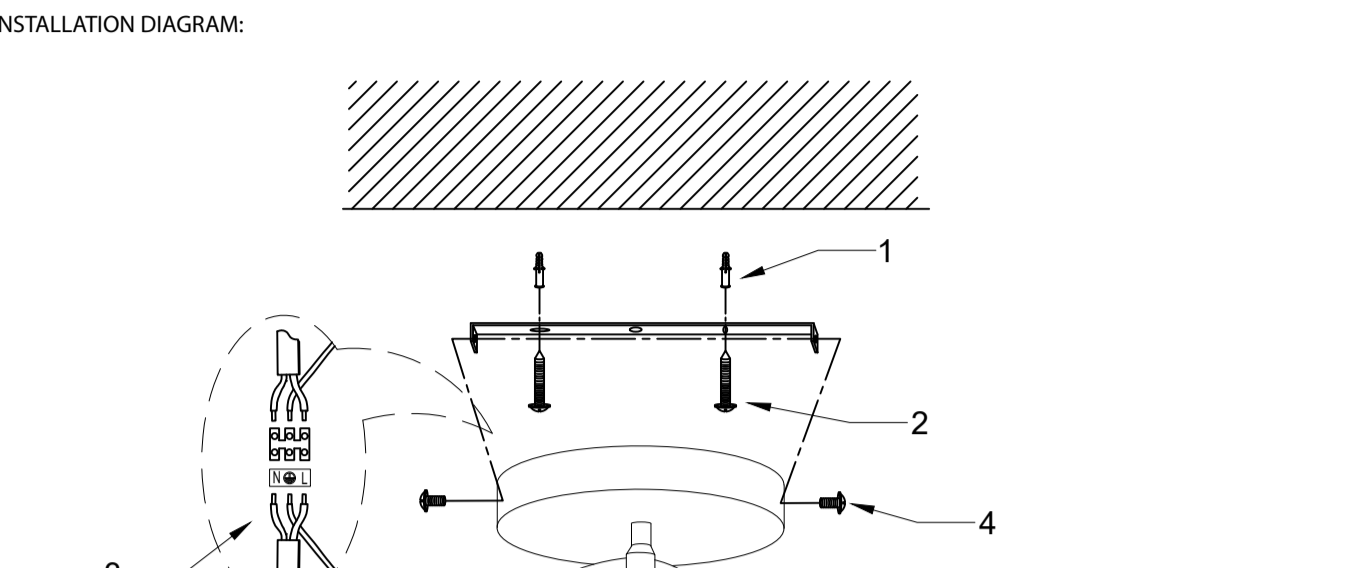
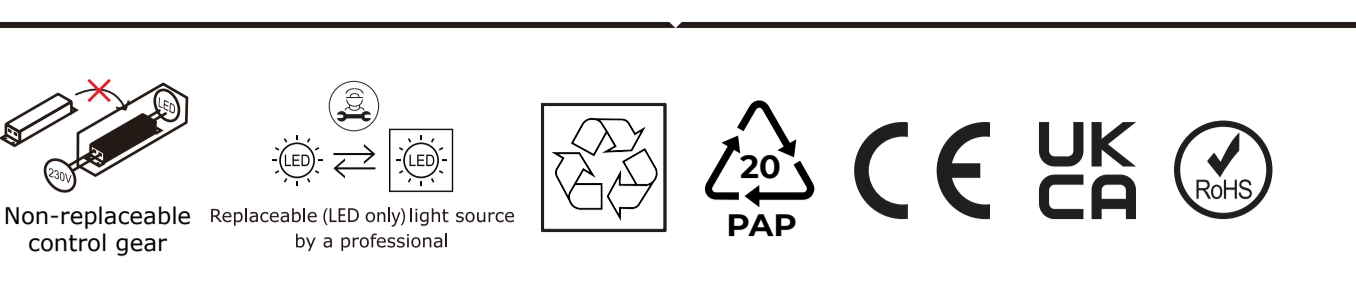
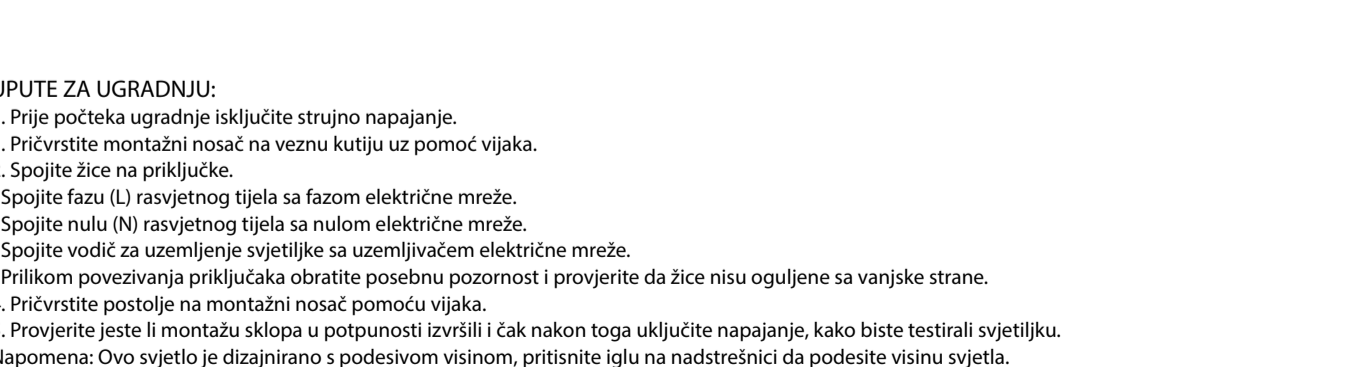
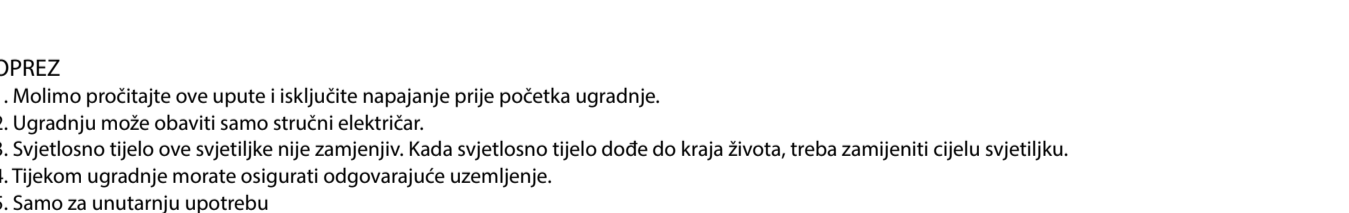
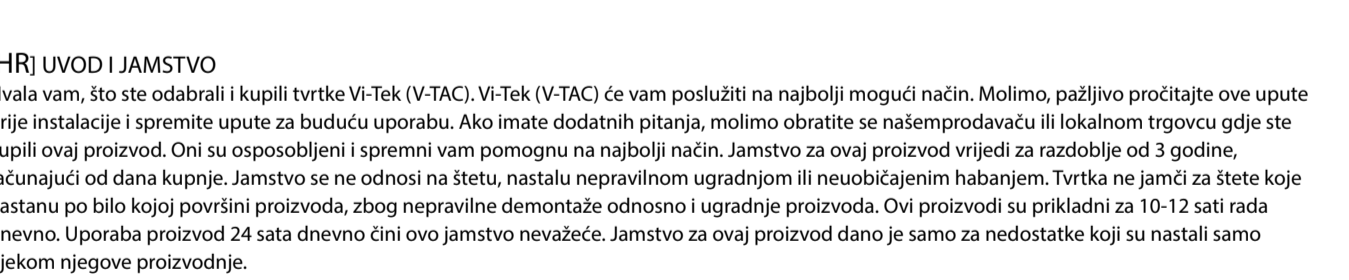
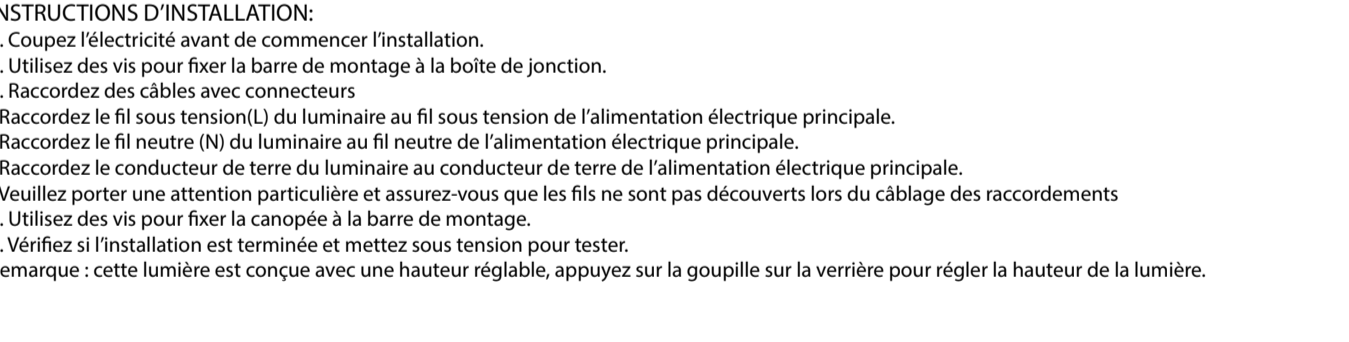
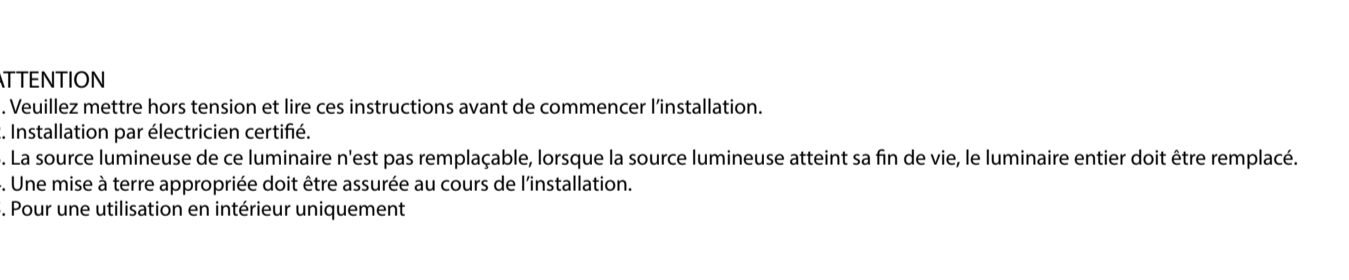

IN CASE OF ANY QUESTIONS WITH THE PRODUCT, PLEASE REACH OUT TO US AT: SUPPORT@V-TAC.UK FOR MORE PRODUCT RANGE, INQUIRY PLEASE CONTACT OUR DISTRIBUTOR OR NEAREST DEALERS.

V-TAC EUROPE LTD. BULGARIA, PLOVDIV 4000, BUL.LSKARAVILOV 98